

CLOCKAUDIO CUT-4

UDP TRANSPORTER

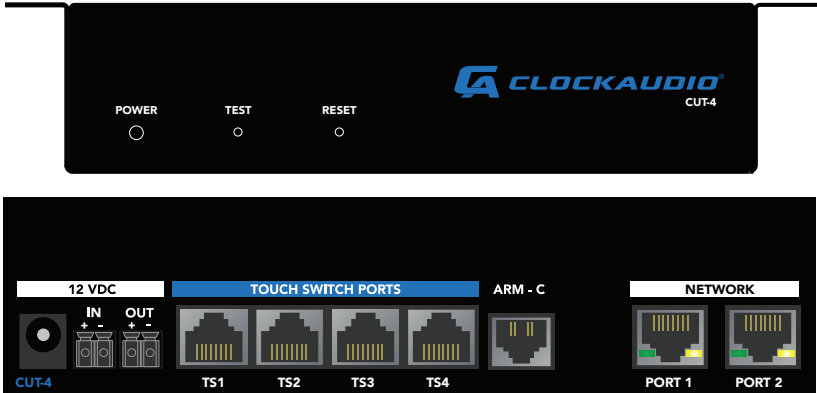

Clockaudio Ltd.

Unit C, Wellington Gate, Silverthorne Way
Waterlooville, Hampshire PO7 7XY
UK

Tel: +44(0)23 9225-1193

Email: info@clockaudio.co.uk

Clockaudio North America Inc.

2891 Rue du Meunier, Unit 103, Vaudreuil-Dorion
QC, Canada J7V 8P2

Toll Free: 1-888-424-9797

Tel: 450-424-9797

Email: info@clockaudio.com

Clockaudio PTE Ltd.

BizTech Centre, Unit # 01-02, 627A Aljunied Road
Singapore, 389842

Tel: +65 67484738

Email: info@clockaudio.com.sg

IMPORTANT SAFETY INSTRUCTIONS



TO REDUCE THE RISK OF FIRE OR ELECTRIC SHOCK, DO NOT EXPOSE THIS APPARATUS TO RAIN OR MOISTURE.

- Read these instructions.
- Keep these instructions.
- Heed all warnings.
- Follow all instructions.
- Do not use this apparatus near water.
- Clean only with a dry cloth.
- Do not block any ventilation openings. Install in accordance with the manufacturer's instructions.
- Do not install near any heat sources such as radiators, heat registers, stoves, or other apparatus (including amplifiers) that produce heat.
- Do not defeat the safety purpose of the polarized or grounding-type plug. A polarized plug has two blades with one wider than the other. A grounding type plug has two blades and third grounding prong. The wider blade or the third prong is provided for your safety. If the provided plug does not fit into your outlet, consult an electrician for replacement of the obsolete outlet.
- Protect the power cord from being walked on or pinched particularly at plugs, convenience receptacles, and the point where they exit from the apparatus.
- Only use attachments/accessories as specified by Clockaudio.
- Refer all servicing to qualified service personnel. Servicing is required when the apparatus has been damaged in any way, such as power supply cord or plug is damaged, liquid has been spilled or objects have fallen into the apparatus, if the apparatus has been exposed to rain or moisture, does not operate normally or has been dropped.
- This apparatus shall be connected to a mains socket outlet with a protective earthing connection.
- If rack mounting, provide adequate ventilation. Equipment may be located above or below this apparatus but some equipment (like large power amplifiers) may cause an unacceptable amount of hum or may generate too much heat and degrade the performance of this apparatus.

LIMITED ONE YEAR WARRANTY

The equipment is warranted for one year from date of purchase from Clockaudio against defects in materials or workmanship.

This warranty does not cover equipment which has been abused or damaged by careless handling or shipping.

This warranty does not apply to used or demonstrator equipment.

Should any defect develop, Clockaudio will, at our option, repair or replace any defective parts without charge for either parts or labor. If Clockaudio cannot correct the defect in the equipment, it will be replaced at no charge with a new item. Clockaudio will pay for the cost of returning the replacement equipment to you.

This warranty applies only to items returned to Clockaudio, shipping costs prepaid, within one year from the date of purchase.

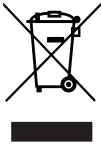

At the end of the life of this equipment, dispose of equipment according to local regulations.

NOTE:

This equipment has been tested and found to comply with the limits for a Class B digital device, pursuant to Part 15 of the FCC Rules and EN55032, EN55035.

These limits are designed to provide reasonable protection against harmful interference when the equipment is operated in a commercial environment.

This equipment generates, uses, and can radiate radio frequency energy and, if not installed and used in accordance with the instruction manual, may cause harmful interference to radio communications.

Operation of this equipment in a residential area is likely to cause harmful interference, in which case the user will be required to correct the interference at their own expense.

CONTENTS

GETTING STARTED	5
FEATURE OVERVIEW	6
IN THE BOX	6
DIAGRAM OF FUNCTIONS	7
CONNECT TOUCH SWITCHES	12
CONNECT POWER	12
TOUCH SWITCH PORT SETUP	16
FRONT PANEL SWITCHES & DEMO/DIAGNOSTIC MODES	16
FRONT PANEL LED INDICATOR	17
CLOCKAUDIO CONTROL PANEL	18
DIAGNOSTIC MODES	20
MOUNTING	21
API SPECIFICATION	24

GETTING STARTED

The CUT-4 logic interface is the ideal interface for adding RGB LED touch buttons to a networked system.

Touch switches, motorized microphone controls, and LED indication is simplified with Touch Switch and ARM-C ports. The small form factor allows the CUT-4 to be installed in close proximity to the Clockaudio RGB touch buttons.

Up to 6 CUT-4 units can be installed in a daisy chain configuration, further reducing the amount of cabling needed.

FEATURE OVERVIEW

- RGB LED control for all Clockaudio RGB LED touch switches.
- 3 logic input pins on each TS port (pins 1, 5 and 8).
- Easy to install with under table mounting flanges.
- Control signals transported over a single network cable.
- Powered by an external regulated +12VDC power supply (sold separately).
- The 4 TS (Touch Switch) connections are fully backward compatible to all previous Clockaudio bicolor touch switches. The ARM-C port provides direct connection to the ARM motorized microphone controller or CCRM4000.
- The CUT-4 features two network connections for Daisy Chaining. This simplifies system infrastructure wiring, allowing a single network cable home run for multiple CUT-4 units.
- Power can also be daisy chained, up to 6 units (additional power considerations are required).
- The CUT-4 can be controlled and monitored with 3rd party control modules using direct UDP messages. Parameters that can controlled include:
 - ARM-C Up/Down
 - LED Status and Brightness level
 - Button Status

IN THE BOX

- CUT-4 Unit
- Quick start card
- 2x 2POS terminal block

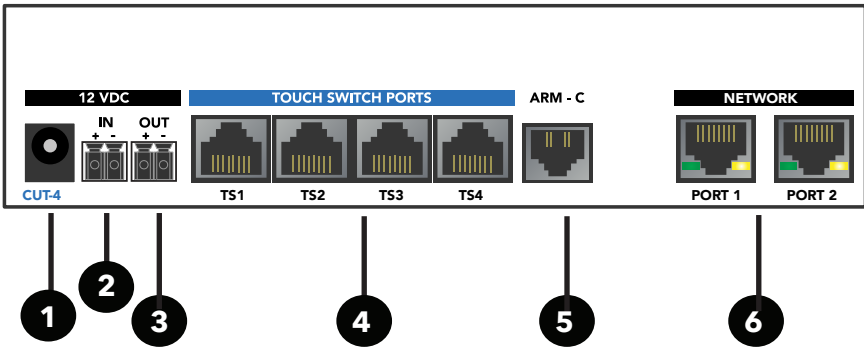
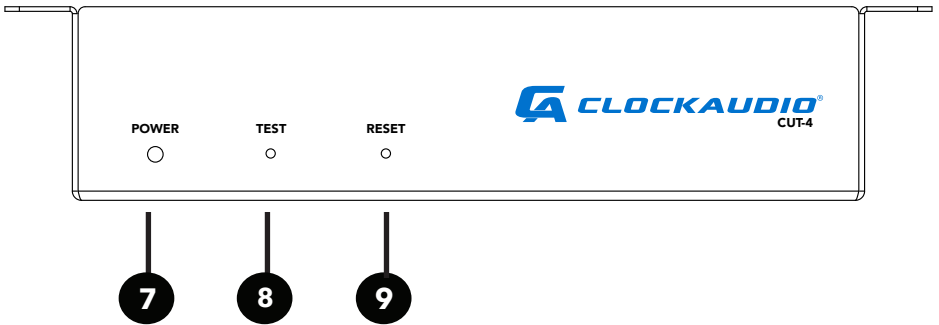

DIAGRAM OF FUNCTIONS

- 1. 12VDC POWER INPUT**
External 12VDC power inlet (center positive)
- 2. POWER INPUT TERMINAL BLOCKS**
12VDC power input for external or daisy chained power
- 3. POWER OUTPUT TERMINAL BLOCKS**
12VDC power output for daisy chaining multiple devices
- 4. TOUCH SWITCH PORT**
RJ45 port for connection to Clockaudio Touch Switch controls
- 5. ARM-C PORT**
ARM-C port for connection to Clockaudio motorized microphone control
- 6. NETWORK PORTS**
Network ports for connecting to the network and daisy chaining multiple devices



7. **POWER ON**

Power and CUT-4 Status Indicator

8. **TEST**

Activates diagnostic and demo modes

9. **RESET**

Resets the test mode and restore defaults (see FRONT PANEL SWITCHES & DEMO/DIAGNOSTIC MODES section for detailed information)

SETTING UP THE CUT-4

We recommend setting up the CUT-4 in the following order. Consult this User Guide for detailed information on each step.

1. Mount the CUT-4
2. Connect Touch Switches and ARM Controller
3. Connect CAT5 cables to the network
4. Connect power supply
5. Connect the Clockaudio Control Panel application for deeper configuration of key features
6. Setup TS Port functionality
7. Setup ARM-C functionality

8. Test features with DEMO/DIAGNOSTIC mode

CONNECTION DIAGRAMS

CONNECTING TS SWITCH

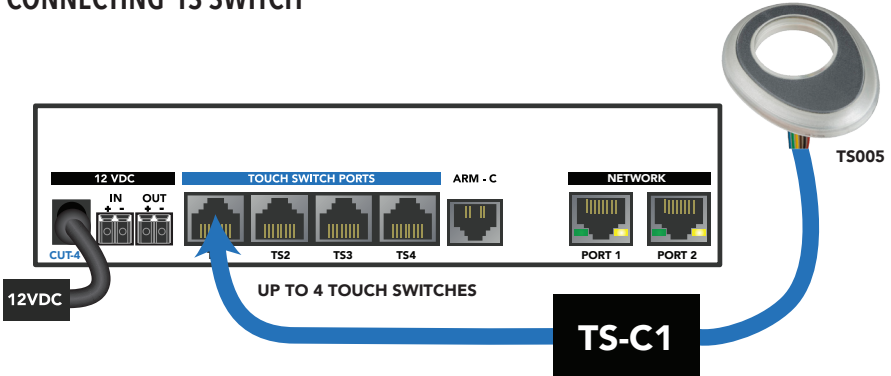

CONNECTING ARM-C MOTORIZED MICROPHONES AND TS SWITCH

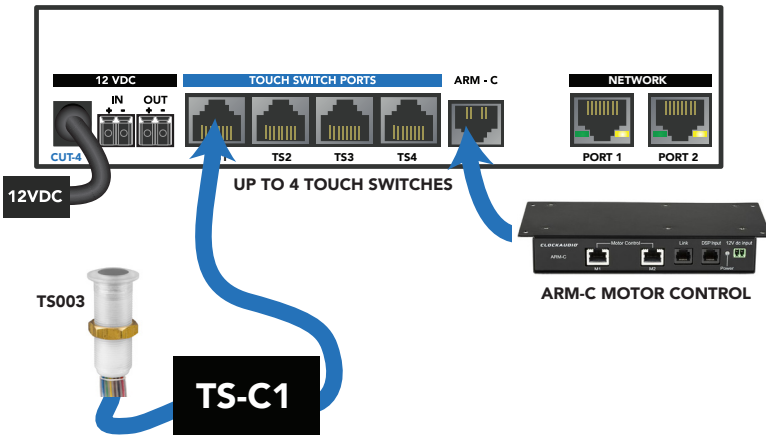

CONNECT TOUCH SWITCHES

The TS PORT allows users to connect a Touch Switch such as the TS 003 or TS 005 to the CUT-4 for microphone muting and unmuting in your DSP.

Each TS Port can be connected to a single Touch Switch. Configure the functions of each switch with the Clock Audio CUT-4 Windows Application.

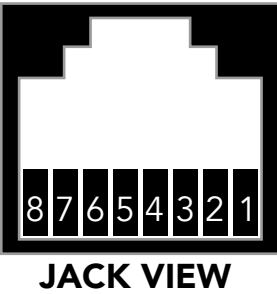

Pins 1, 5, and 8 are Switch Logic Inputs (GPIOs). These are pins that the DSP or control system reads the Hi/Low status and reacts as programmed (3.3V, switch for Clockaudio control devices is Pin 5)

Pins 2, 6, and 7 act as GPI/O Outputs or relays/contact closures, that ground to Pin 3, the common ground.

PIN 3 is the Common Ground.

PIN 4 is the 12V supply for LED power and switch operation. Maximum Power Output 50mA.

TS PINOUT DIAGRAM	
PIN 1	Logic Input (3.3V logic high) to detect the Reed switch on Clockaudio CRM series microphones
PIN 2	Negative (-) lead for RED LEDs on Clockaudio devices
PIN 3	Common Ground for LED, Switch operation, & Reed switch ground
PIN 4	12V (+) supply for LED and Switch operation on Clockaudio control devices
PIN 5	Logic Input (3.3V logic high)
PIN 6	Negative (-) lead for GREEN LEDs on Clockaudio devices
PIN 7	Negative (-) lead for BLUE LEDs on Clockaudio devices
PIN 8	Logic Input (3.3V logic high) for user defined logic Input

CONNECT ARM-C CONTROLLER

The ARM-C port connects to an optional ARM-C controller for use with boundary mics that have motorized retraction features.

Connect the ARM-C device to the port labels ARM-C with a standard RJ12 cable.

Use Clockaudio Control Panel application to test ARM-C functionality.

CONNECT POWER

Connect a 12VDC power supply (sold separately). If using multiple CUT-4 devices in a daisy chain configuration, see power considerations in the Daisy Chaining section of this manual.

Attach the power supply to the power input jack. The power light on the front should illuminate green to indicate normal operation. There may also be some activity on the CUT-4 network port LED indicators.

When not connected, both LEDs will remain off. If an active connection is made, the green LED will illuminate and blink to indicate network activity. The second LED will illuminate yellow to indicate the network speed (on is 1Gbit, off is 100 Mbit).

DAISY CHAINING CUT-4 UNITS

A unique feature of the CUT-4 is the ability to connect up to 6 units in a daisy chain configuration. Both power and network data can be daisy chained, resulting in decreased installation costs and simplified installs.

DATA DAISY CHAINING

To connect multiple CUT-4 units in a daisy chain, connect the first unit directly to the network as explained above. Connect one of the network ports on the second device to the open network port on the first device. Each additional device (up to six) can be connected in the same manner.

POWER DAISY CHAINING

Connect the first CUT-4 to an adequate power supply. To supply the proper power to each of up to 6 devices, one of the CUT-4 devices in the chain must be connected to an external power supply that provides 12VDC and appropriate voltage (see chart in the Power Considerations section for approximate requirements).

Use the OUTPUT terminal on the first device to daisy chain power to the INPUT terminal on the second device. Connect the first device positive (+) OUTPUT terminal to the positive INPUT terminal on the second device. Connect the first device negative (-) terminal to the negative INPUT terminal on the second device.

POWER CONSIDERATIONS:

The number of devices supported in a daisy chain configuration will be determined by the power supplied to the system. Ensure a proper power supply is used when connecting multiple devices.

Single CUT-4: 12VDC at $\approx 4W^*$

Two CUT-4 units: 12VDC at $\approx 8W^*$

Three CUT-4 units: 12VDC at $\approx 12W^*$

Five CUT-4 units: 12VDC at $\approx 20W^*$

Six CUT-4 units: 12VDC at $\approx 24W^*$

* CUT-4 units only, no additional connected devices

Additional power requirements must be considered when using Touch Switch ports with the CUT-4. Each Touch Switch that is connected will increase power requirements. When using multiple units in a daisy chain configuration, please consider the total system power requirements.

TS PORT POWER REQUIREMENTS

Each Touch Switch port with a connected LED may require between 1 watt and 3.5 watts depending on the Touch Switch configuration. When using multiple Touch Switches, this number must be multiplied by the number of connected Touch Switches.

DAISY CHAINING CUT4 UNITS

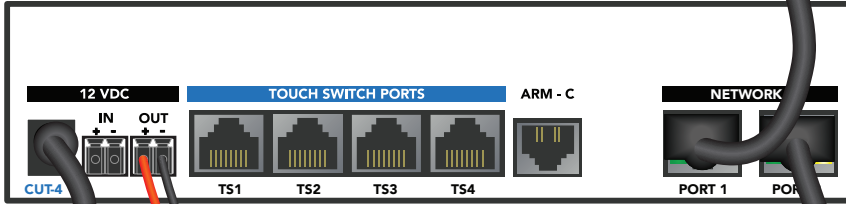
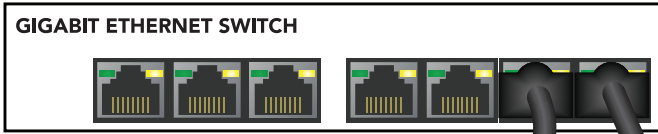

2VDC

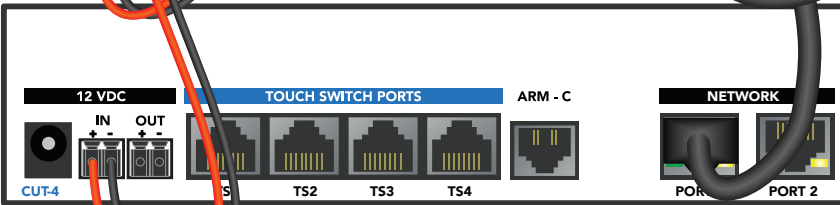
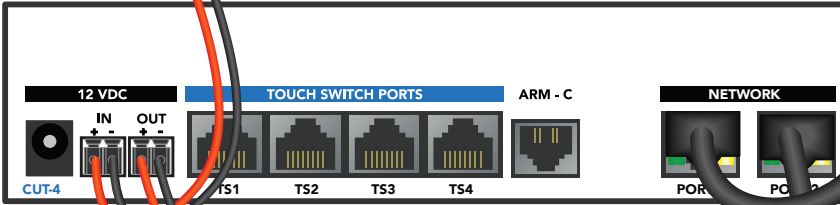

CONNECT UP TO 6 DEVICES TOTAL IN
DAISY CHAIN CONFIGURATION

TOUCH SWITCH PORT SETUP

The TS PORT allows users to connect a Touch Switch such as the TS 003 or TS 005 to the CUT-4.

To test Touch Switch configuration, use the Clockaudio Control Panel application. Please consult the Clockaudio Control Panel manual for detailed instructions.

FRONT PANEL SWITCHES & DEMO/DIAGNOSTIC MODES

The front-panel TEST button allows the user to switch between Normal operation, TS Port Test Mode and Demo Mode.

TS PORT TEST MODE: While in normal operation, press and hold the TEST button for 5 seconds to activate TS Port Test Mode. In this mode, each connected Touch Switch will turn RED. Each time the Touch Switch is touched, the color will cycle. This allows testing of connected Touch Switches and LEDs.

DEMO MODE: While in TS Port Test Mode, press and hold the TEST button for 5 seconds to active Demo Mode. In this mode, each Touch Switch connected to a TS PORT will illuminate, cycling through the color spectrum.

To return to Normal Operation, press and hold RESET for 5 seconds.

ADDITIONAL TEST MODES

Additional mode and a Latency test mode can be accessed with the Clockaudio Control Panel application. Please consult this portion of the manual for more information.

RESTORE DEFAULT VALUES

PRESS and HOLD the RESET button for 30 seconds to reset all configuration settings to the default values. A long red flash on the front-panel LED will indicate the reset has been successful. After a successful reset, power cycle the CUT-4.

If there was an issue resetting the CUT-4 to the default values, the front panel LED will flash 8 quick red flashes. If you see 8 quick red LED flashes, try to reset the system again by holding the RESET for an additional 30 seconds.

EMERGENCY FIRMWARE RECOVERY

Holding both the TEST and RESET buttons while powering on the CUT-4 will cause the unit to enter emergency firmware recovery mode. When both buttons are pressed while powering on the unit, the last downloaded firmware will be loaded into the system.

FRONT PANEL LED INDICATOR

The front-panel Power LED also serves as a status indicator.

GREEN: The CUT-4 is functioning normally.

YELLOW: The CUT-4 is in firmware update mode.

BLINKING YELLOW: A firmware update is in progress.

1 LONG RED FLASH: Configuration settings were successfully reset.

3 LONG RED FLASHES: The +12V input power supply voltage is too high. This will repeat every 15 seconds until the voltage is restored to the proper level.

3 SHORT RED BLINKS: The +12V input power supply voltage is too low. This will repeat every 15 seconds until the voltage is restored to the proper level.

4 SHORT RED BLINKS: Firmware updated failed.

8 SHORT RED BLINKS: Configuration settings could not be reset to the default settings.

CLOCKAUDIO CONTROL PANEL

The Clock Audio Control Panel for Windows computers provides additional functions for setting up the CUT-4. This section describes some of the basic controls but is not intended to be exhaustive. Please consult the Clockaudio Control Panel manual for additional functionality.

The Clockaudio Control Panel application will need to communicate to the CUT-4 over the network. All Dante devices will be discovered regardless of the IP address setup on the PC, however, communication with the CUT-4 Windows application requires a compatible IP addresses.

By default, the CUT-4 will receive a dynamic IP address. If there is no DHCP server to assign an IP address, the device will self-assign an IP address. This IP address will always start with 169.254.x.x.

To ensure communication, the Windows PC running the CUT-4 application must be on the same subnet as the CUT-4 device.

CLOCKAUDIO CONTROL PANEL CONFIGURATION

DEVICE SELECTION

Depending on the configuration, multiple CUT-4 units may be active on the network. Use the window on the left side to select a CUT-4 unit to setup.

DEVICE INFO

This section displays the product name, unique identifier, IP addresses and Mac address.

Control IP: IP address of the CUT-4 for addressing with an external controller

ASYNCHRONOUS IP ADDRESS

If using an external controller, enter the IP and port in this section. The CUT-4 will report device status updates to this external device.

ARM-C

To activate motorized microphones (if installed) select the box labeled ARM-C.

TS PORTS

Select the color of connected TS Port capacitive touch switches with the Red, Green, Blue selection boxes and the Brightness controls. You can select multiple colors for a wide color palette.

The SWITCH STATUS indicators let you know what TS PORT switches are currently activated.

TS - Touch Switch

US - Third party User Switch

RS - Reed Switch

DIAGNOSTIC MODES

Access the demo and diagnostic modes by selecting Diagnostics from the Tools menu (top menu bar).

DEMO

In DEMO mode, each Touch Switch connected to a TS PORT will illuminate, cycling through the color spectrum.

TS

In TS Port Test mode, each connected Touch Switch will turn RED. Each time the Touch Switch is pressed the color will cycle. This allows testing of connected Touch Switches and LEDs. This mode can also be activated from the front-panel test button.

LATENCY

Latency test mode measures how long it takes for a TS Port change message sent from the CUT-4 to be received on an external controller.

The application displays statistics about the number of messages sent/received and the measured latency. An external controller is required for this mode. The external controller's IP address and port must be configured in the Asynchronous IP Address area of the application.

MOUNTING

It is recommended that the CUT-4 be secured to a flat surface with a screw through each mounting flange. Dimensions for mounting are shown in Figure 9 below. Use a No. 6 screw of a type and size that is applicable to the surface to which the CUT-4 will be attached

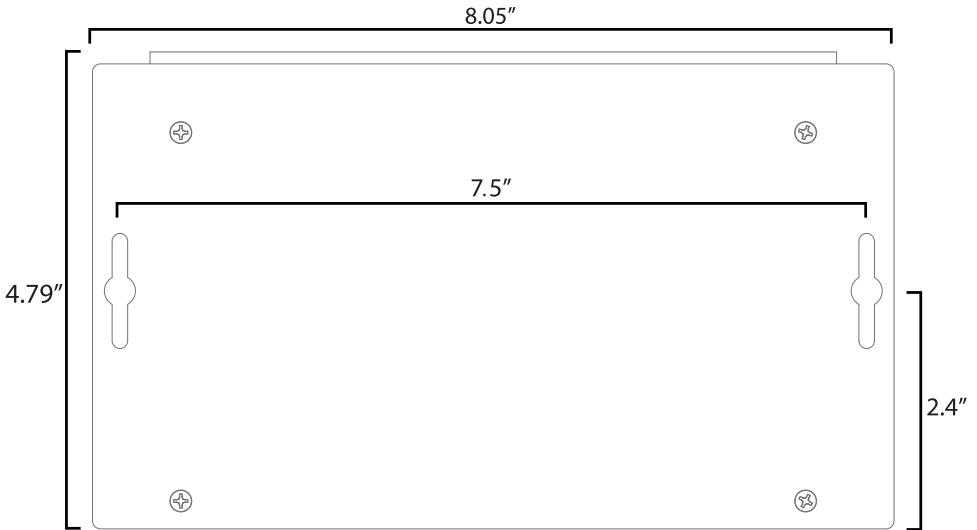

CONSUTANTS SPECIFICATIONS

Four control ports will be available for interfacing with switch buttons and RGB LED.

An interface for motorized microphones shall be included.

The CUT-4 unit shall be compatible with third party control systems for flexible control.

The CUT-4 unit shall be compliant with the EMI/EMC requirements for FCC and CE.

TECHNICAL SPECIFICATIONS

GENERAL SPECIFICATIONS	
TS Control Device Input	RJ45, interfaces with Clockaudio TS-C1 and Clockaudio Touch Switches
ARM-C Interface	RJ12
Power Consumption	4 Watts nominal
Max Product Dimensions	8.05" x 4.79" x 2"
Mounting Slot Mounting Dimension	7.5" (center to center)
Recommended Mounting Screw	#6
Unit Weight	1.75 lbs
Packaged Weight	2 lbs
Compliance	FCC CFR 47 Parts 15B ICES-003 CE (EN55032, EN55035) RoHS, WEEE
NETWORK	
Physical Level	Standard Ethernet
Connector	RJ45
Cable Requirements	CAT5e, CAT6 (shielded recommended)
Transmission Speed	1 Gbps

API SPECIFICATION

1 UDP COMMAND SYNTAX

The following commands are available for the CUT-4. Commands are sent to UDP port 49494 on the target device. Responses are returned to the sending UDP port number. Please keep in mind that UDP is not a “guaranteed delivery” protocol, so it is possible for commands and responses to be occasionally lost. Clients should take appropriate measures to handle dropped packets.

1.1 CUT-4 Command Set

Description	Command	Param 1	Param 2
Identify Device	ID	Mode (0 = off, 1 = on)	-
Find Unit	FU	-	-
Load preset values	LOAD	x (x = 0)	-
Save preset values	SAVE	x (x = 0)	-
Version Info	VERSION	-	-
Retrieve current settings	QUERY	-	-
Reset to factory defaults	DEFAULTS	-	-
Set ARM-C State	SARMC	0 = Off, 1 = On	-
Get ARM-C State	GARMC	-	-
Set Async IP Address	SASIP	xxx.xxx.xxx.xxx:yyyy	
Get Async IP Address	GASIP	-	
Firmware Update	FWUPDATE	-	
Boot Loader Version	BVERSION	-	
Set TS State	STS	TS # (x) x = 0 : All channels x = [1...4]	R=(0 = off or 1 = on) or G=(0 = off or 1 = on) or B=(0 = off or 1 = on)
Get TS Status	GTS	TS # (x) x = 0 : All channels x = [1...4]	

Set TS Brightness	STSB	TS # (x) x = 0 : All channels x = [1...4]	R=(10, 20, 30, 40, 50, 60, 70, 80, 90, 100) or G=(10, 20, 30, 40, 50, 60, 70, 80, 90, 100) or B=(10, 20, 30, 40, 50, 60, 70, 80, 90, 100)
Get TS Brightness	GTSB	TS # (x) x = 0 : All channels x = [1...4]	
Set RGB state	SRGB	TS # (x) x = 0 : All channels x = [1...4]	0..255 0..255 0..255 RGB intensity
Get RGB State	GRGB	TS # (x) x = 0 : All channels x = [1...4]	
Set Global Brightness Control	SGBC	0..127 0..127 0..127	
Get Global Brightness Control	GGBC		
Display demo mode	DEMO	ON or OFF	
Set Test Mode	TESTMODE	Test mode (x) x = 0: turn off test mode x = 1: Demo mode x = 2: TS Port Test mode x = 4: Latency Test mode	
Get Latency Test Mode Measurements	GLATENCY		
Set Control Port IP Address Configuration	SETCTLNET	(see description, below)	(see description, below)
GET Control Port IP Address Configuration			
Reboot Device	Reboot		

1.2 General Command Handling

Commands are sent as ASCII character string with spaces used to delimit fields within a command. The entire command is terminated with a Carriage Return (0x0D). The device acknowledges a command by returning the command data with the string "ACK" inserted preceding the command data. If the device could not process a command, then the command is "NACKed". The string "NACK" is inserted preceding the data that was sent. NACKs are returned for unknown commands, commands with invalid parameters, or for a LOAD command for a preset that has not been previously SAVED.

1.3 Command Descriptions

1.3.1 Identify/Find Unit

The Identify and Find Unit commands are both used to permit a given unit to be physically identified. Both commands cause the Power LED to flash at an approximate rate of 330 milliseconds / on / off. The difference between the commands is that the Identify command has an ON / OFF parameter and remains in the selected state until a new Identify command (or CUT-4 reset event) is sent to change state. The Find Unit command flashes the Power LED for 5 seconds, the Power LED function then resumes without sending any additional commands. The Power LED will also flash when the Dante Controller "Identify Device" function is used.

Set Identify on:

```
ID 1<CR>
```

Response:

```
ACK ID 1<CR>
```

Activate Find Unit:

```
FU<CR>
```

Response:

```
ACK FU<CR>
```

1.3.2 Load/Save

The LOAD and SAVE commands allow different configurations to be saved into preset 0. When the CUT-4 starts up preset 0 is used as the default configuration. A preset saves the CUT-4 configuration, including the phantom power settings, the TS brightness settings and the ARM-C setting. In preparation to save a preset the various commands (PP, STSB, SARMC) are sent to the CUT-4 to configure it into the desired state, then the SAVE command is issued to save that configuration to a preset. Attempting to LOAD a preset that has never been saved will result in a NACK being returned.

Save the current CUT-4 settings to preset 0, which would then be used as the startup settings.

```
SAVE 0<CR>
```

Response:

```
ACK SAVE 0<CR>
```

1.3.3 Version

The VERSION command returns the current version of the Host MCU firmware. The command has no parameters.

Request the MCU firmware version:

```
VERSION<CR>
```

Response:

```
ACK VERSION x.y<CR>
```

Where x is the major version number and y is the minor version number

The VERSION command only returns the version of the Host MCU firmware. For the version of the Ultimo (Dante) firmware the Dante Controller application should be used.

1.3.4 Query

A QUERY command allows the control system to get a snapshot of the current state of the Phantom Power for all channels and the current Identify Mode. The command has no parameters.

Request the Phantom Power and Identify Mode:

```
QUERY<CR>
```

Response:

```
ACK QUERY PP1=OFF PP2=ON PP3=OFF PP4=OFF ID=OFF<CR>
```

This response shows that channels 1, 3 and 4 Phantom Power is off, Channel 2 Phantom Power is on and the Identify Mode is off.

1.3.5 Defaults

The DEFAULTS command sets phantom power on all channels to off, places the TS LEDs outputs in the inactive state and sets the ARM-C control output to the inactive state. This state is then stored to preset 0.

To set the CUT-4 so that preset 0 has factory settings:

```
DEFAULTS<CR>
```

Response

```
ACK DEFAULTS<CR>
```

1.3.6 Set ARM-C State

The Set ARM-C State command provides for activating or deactivating the ARM-C control signal.

The following command activates the ARM-C control signal.

```
SARMC 1<CR>
```

Response

```
ACK SARMC <CR>
```

1.3.7 Get ARM-C State

The Get ARM-C State command provides to retrieving the current state of the ARM-C control signal.

```
GARMC<CR>
```

Response:

```
ACK GARMC x<CR>
```

Where x is 0 = inactive, 1 = active

1.3.8 Set Asynchronous IP Address

The Set Asynchronous IP Address command is used to set the IP address and port number of the network node that asynchronous (unpolled) responses are sent to. Currently only the Switch Logic states from the four TS devices are reported. The following example command would setup the CUT-4 to send message to port 12345 of node 192.168.50.4 when a switch changes state.

```
SASIP 192.168.50.4:12345<CR>
```

Response:

```
ACK SASIP 192.168.50.4:12345<CR>
```

Switch state change messages are sent as BSTATUS messages. BSTATUS messages are in the following format.

```
BSTATUS Bx=y<CR>
x = switch indicator
```

1	TS Port 1 touch switch
2	TS Port 2 touch switch
3	TS Port 3 touch switch
4	TS Port 4 touch switch
5	TS Port 1 user input
6	TS Port 1 RS input
7	TS Port 2 user input
8	TS Port 2 RS input
9	TS Port 3 user input
10	TS Port 3 RS input
11	TS Port 4 user input
12	TS Port 4 RS input

touch switch = RJ-45 pin 5

user input = RJ-45 pin 8

RS input (RS-IN) = RJ-45 pin 1

y = switch state, 0 = inactive (not touched), 1 = active (touched)

Examples

```
BSTATUS B2=1<CR>
```

This message indicates that TS Port 2 touch switch changed to active (touched).

```
BSTATUS B6=1<CR>
```

This message indicates that TS Port 1 RS input changed to active.

```
BSTATUS B9=0<CR>
```

This message indicates that TS Port 3 user input changed to inactive.

1.3.9 Firmware Update

The Firmware Update command reboots the CUT-4 into an update mode. The command has no parameters.

```
FWUPDATE
```

Response:

None – the unit will immediately re-boot and the LED will change to yellow.

1.3.10 Boot Version

The BVERSION command returns the current version of the Host MCU boot-loader firmware. The command has no parameters.

Request the MCU boot-loader firmware version:

```
BVERSION<CR>
```

Response:

```
ACK BVERSION x.y<CR>
```

Where x is the major version number and y is the minor version number of the boot-loader.

1.3.11 Set TS State

The Set TS State command provides for setting the state of the Red or Green LEDs on either all four TS ports, or a selected TS port.

The following command sets the Red LEDs on all four TS ports to on:

```
STS 0 R=1<CR>
```

Response:

```
ACK STS 0 R=1<CR>
```

The following command sets the Red LED on TS port 1 to off:

```
STS 1 R=0<CR>
```

Response:

```
ACK STS 1 R=0<CR>
```

The following command sets the Green LEDs on all four TS ports to on:

```
STS 0 G=1<CR>
```

Response:

```
ACK STS 0 G=1<CR>
```

The following command sets the Green LED on TS port 4 to off:

```
STS 4 G=0<CR>
```

Response:

```
ACK STS 4 G=0<CR>
```

The following command sets the Blue LED on TS port 4 to on:

```
STS 4 B=1<CR>
```

Response:

```
ACK STS 4 B=1<CR>
```

1.3.12 Get TS Status

The Get TS status command is used to retrieve the logic input / output state of either all four ports or a selected port. The data is formatted similarly for each channel.

CHxR=y provides the current state for channel x Red LED,
y = 0 for inactive, 1 for active

CHxG=y provides the current state for channel x Green LED,
y = 0 for inactive, 1 for active

CHxB=y provides the current state for channel x Blue LED,
y = 0 for inactive, 1 for active

CHxSCi=y provides the current state for channel x Switch Logic Control,
y = 0 for inactive, 1 for active,
i = 1 for touch switch, 2 for RS-IN input, 3 for user input

The following command returns the status of all four TS ports:

```
GTS 0<CR>
```

Response:

```
ACK GTS 0 CH1R=0 CH1G=1 CH1B=1 CH1SC1=0 CH1SC2=1  
CH1SC3=0 CH2R=1 CH2G=1 CH2B=1 CH2SC=1 CH2SC2=0  
CH2SC3=0 CH3R=0 CH3G=1 CH3B=1 CH3SC1=0 CH3SC2=0  
CH3SC3=0 CH4R=0 CH4G=1 CH4B=1 CH4SC1=0 CH4SC2=0  
CH4SC3=0<CR>
```

The following command returns the status of TS port 2:

```
GTS 2<CR>
```

Response:

```
ACK GTS 2 CH2R=0 CH2G=1 CH2B=1 CH2SC1=1  
CH2SC2=0 CH2SC3=0
```

1.3.13 Set TS Brightness

The Set TS Brightness command provides for setting the brightness of the Red or Green LEDs on either all four TS ports, or a selected TS port. The brightness levels are implemented as a "duty cycle". The duty cycle is set in 10% increments so valid values are 10, 20, 30, 40, 50, 60, 70, 80, 90 and 100.

The following command sets the brightness of the Red LEDs on all four TS ports to 50%:

```
STSB 0 R=50<CR>
```

Response:

```
ACK STSB 0 R=50<CR>
```

The following command sets the brightness of the Red LED on TS port 1 to 70%:

```
STSB 1 R=70<CR>
```

Response:

```
ACK STSB 1 R=70<CR>
```

The following command sets the brightness of the Green LEDs on all four TS ports to 60%:

```
STSB 0 G=60<CR>
```

Response:

```
ACK STSB 0 G=60<CR>
```

The following sets the brightness of the Green LED on TS port 4 to 20%:

```
STSB 4 G=20<CR>
```

Response:

```
ACK STSB 4 G=20<CR>
```

1.3.14 Get TS Brightness

The Get TS brightness command is used to retrieve the brightness level of either all TS LEDs or the brightness level of the LEDs on a selected port. The data is formatted similarly for each channel.

CHxR=y provides the brightness level for channel x Red LED, y = 10..100

CHxG=y provides the brightness level for channel x Green LED, y = 10..100

CHxB=y provides the brightness level for channel x Blue LED, y = 10..100

The following command returns the brightness level of all four TS ports:

```
GTSB 0<CR>
```

Response:

```
ACK GTSB 0 CH1R=50 CH1G=30 CH1B=30 CH2R=10 CH2G=100  
CH2B=100 CH3R=40 CH3G=50 CH3B=100 CH4R=100 CH4G=100  
CH4B=100 <CR>
```

The following command returns the brightness level of TS port 2:

```
GTSB 2<CR>
```

Response:

```
ACK GTSB 2 CH2R=50 CH2G=100<CR>
```

1.3.15 Set RGB State

The Set RGB State command provides for setting the brightness of the Red, Green and Blue LEDs in the TS(s).

The following command sets the LEDs channel 1 to full on.

```
SRGB 1 255 255 255<CR>
```

Response:

```
ACK SRGB 1 255 255 255<CR>
```

1.3.16 Get RGB State

The Get RGB State command provides for setting the brightness of the Red, Green and Blue LEDs in the TS(s).

The following command returns the RGB level of all four TS ports:

```
GRGB 0<CR>
```

Response:

```
ACK GRGB 0 CH1 200 167 167 CH2 67 95 100  
CH3 40 50 100 CH4 100 100 100<CR>
```

1.3.17 Set Global Brightness Control

The Set Global Brightness Control command provides for setting the global brightness control for each individual color. This same setting applies to all of the channels. It is used to permit control of the brightness for the color type of the LED. Each color can be set to a value between 0 (off) and 127 (max brightness)

The following command sets the Global Brightness Control

```
SGBC 127 127 127<CR>
```

Response:

```
ACK SGBC 127 127 127<CR>
```

1.3.18 Get Global Brightness Control

The Get Global Brightness Control command returns the current setting of the global brightness control for each individual color. Each color can be set to a value between 0 (off) and 127 (max brightness)

The following command gets the Global Brightness Control

```
GGBC<CR>
```

Response:

```
ACK GGBC 127 127 127<CR>
```

1.3.19 Display Demo Mode

The Display Demo Mode command provides a way to put the device into a demonstration mode that cycles each TS Port's LEDs through the color spectrum.

The following command turns on Display Demo Mode:

```
DEMO ON<CR>
```

Response:

```
ACK DEMO ON<CR>
```

The following command turns off Display Demo Mode:

```
DEMO OFF<CR>
```

Response:

```
ACK DEMO OFF<CR>
```

1.3.20 Set Test Mode

The Set Test Mode command allows various test modes to be activated. These test modes are useful during system configuration and installation. All test modes are mutually exclusive. The following test modes are available.

0 = Test mode off

Turns test mode off, returning the device to normal operation.

1 = Demo mode

Turns on demo mode (same "DEMO ON" command). See DEMO command for details.

2 = TS Port Test mode

Turns on TS Port Test mode. In TS Port Test mode, each TS Port's LEDs are turned on in the "Red" state. Each touch of the TS Port's touch switch causes the LEDs to cycle red/green/blue/red/etc. This provides an easy way to test the TS Port switches and LEDs without requiring external equipment.

3 = VU Meter mode

Turns on VU Meter mode. In VU Meter mode, each TS Port's LEDs are used as a "signal level" indicator, allowing the microphone gain to be adjusted so the signal is at an appropriate level.

off = below -40 dBFS (no meaningful signal present)

green = -40 to -6 dBFS (signal present)

yellow = -6 to -3 dBFS (signal at optimal input level; should be yellow during loud input peaks)

red = above -3 dBFS (signal close to or at clipping level; avoid red for best audio performance)

4 = Latency Test mode

Turns on Latency Test mode. Latency Test mode measures the time delay between a TS Port touch switch state change message being sent and a LED state change message arriving. This allows the response time of the associated network and control system to be measured.

For this measurement to work, the following rules must be followed.

- A control system must be present, and its IP address and port number must be configured with the SASIP command.
- The control system must send STS, STSB or SRGB LED state change messages upon receipt of BSTATUS switch state change messages.
- After touching or releasing a switch, wait for the LEDs to change state before touching or releasing another switch.

The "GLATENCY" command is used to retrieve the measurements. Each time Latency Test mode is turned on, the measurement counters are reset to 0.

The following command turns on VU Meter mode:

```
TESTMODE 3<CR>
```

Response:

```
ACK TESTMODE 3<CR>
```

1.3.21 *Get Latency Test Mode Measurements*

The Get Latency Test Mode command returns the most recent Latency Test measurement statistics. The statistics returned are the number of TS port touch switch messages sent, the number of LED change reply messages not received, and the minimum, average and maximum measured latencies, in milliseconds.

The following command returns the Latency Test measurements:

```
GLATENCY<CR>
```

Response:

```
ACK GLATENCY 4 1 50 108 150<CR>
```

This response indicates that 4 TS port switch messages were sent, 1 LED change reply was not received, the minimum measured latency was 50 msec, the average measured latency was 108 msec and the maximum measured latency was 150 msec.

1.3.22 Set Control Port IP Address Configuration

The Set Control Port IP Address Configuration command configures the IP address for the control port of the device. The IP address, subnet mask and gateway IP address can be configured. Dynamic addressing (DHCP or APIPA (Auto IP, 169.254.x.x)) can be selected by using addresses of all 0's. The new configuration will take effect the next time the device is booted.

There are three parameters to this command: the IP address, the subnet mask and the gateway IP address.

The following command configures the control port IP address to 10.88.102.37, the subnet mask to 255.0.0.0 and the gateway IP to 10.0.0.1:

```
SETCTLNET 10.88.102.37 255.0.0.0 10.0.0.1<CR>
```

Response:

```
ACK SETCTLNET 10.88.102.37 255.0.0.0 10.0.0.1<CR>
```

The following command configures the control port to use dynamic addressing (DHCP/APIPA):

```
SETCTLNET 0.0.0.0 0.0.0.0 0.0.0.0<CR>
```

Response:

```
ACK SETCTLNET 0.0.0.0 0.0.0.0 0.0.0.0<CR>
```

1.3.23 Get Control Port IP Address Configuration

The Get Control Port IP Address Configuration command returns the configured IP address settings for the control port of the device, including the IP address, subnet mask and gateway IP address. If dynamic addressing is configured, addresses of all 0's will be returned. Please note that the values returned by this command are the settings that have been programmed to be used on the next reboot, not the currently assigned IP address, subnet mask and gateway IP address.

The following command returns the configured control port IP address settings, when the IP address is static:

```
GETCTLNET<CR>
```

Response:

```
ACK GETCTLNET 192.168.18.105 255.255.255.0  
192.168.18.1<CR>
```

The following command returns the configured control port IP address settings, when the IP address is dynamic:

```
GETCTLNET<CR>
```

Response:

```
ACK GETCTLNET 0.0.0.0 0.0.0.0 0.0.0.0<CR>
```

1.3.24 Reboot Device

The Reboot Device command causes the device to reboot. This command is useful after changing the network configuration; by rebooting the device, the new network configuration settings will be applied.

The following command reboots the device:

```
REBOOT<CR>
```

Response:

```
ACK REBOOT<CR>
```

Open-Source License Compliance

The firmware in the CUT-4 uses open-source software. To comply with the licensing requirement of this software, please note the following license information.

lwIP TCP/IP Stack

Copyright (c) 2001-2004 Swedish Institute of Computer Science. All rights reserved.

Redistribution and use in source and binary forms, with or without modification, are permitted provided that the following conditions are met:

1. Redistributions of source code must retain the above copyright notice, this list of conditions and the following disclaimer.
2. Redistributions in binary form must reproduce the above copyright notice, this list of conditions and the following disclaimer in the documentation and/or other materials provided with the distribution.
3. The name of the author may not be used to endorse or promote products derived from this software without specific prior written permission.

THIS SOFTWARE IS PROVIDED BY THE AUTHOR "AS IS" AND ANY EXPRESS OR IMPLIED WARRANTIES, INCLUDING, BUT NOT LIMITED TO, THE IMPLIED WARRANTIES OF MERCHANTABILITY AND FITNESS FOR A PARTICULAR PURPOSE ARE DISCLAIMED. IN NO EVENT SHALL THE AUTHOR BE LIABLE FOR ANY DIRECT, INDIRECT, INCIDENTAL, SPECIAL, EXEMPLARY, OR CONSEQUENTIAL DAMAGES (INCLUDING, BUT NOT LIMITED TO, PROCUREMENT OF SUBSTITUTE GOODS OR SERVICES; LOSS OF USE, DATA, OR PROFITS; OR BUSINESS INTERRUPTION) HOWEVER CAUSED AND ON ANY THEORY OF LIABILITY, WHETHER IN CONTRACT, STRICT LIABILITY, OR TORT (INCLUDING NEGLIGENCE OR OTHERWISE) ARISING IN ANY WAY OUT OF THE USE OF THIS SOFTWARE, EVEN IF ADVISED OF THE POSSIBILITY OF SUCH DAMAGE.

The lwIP TCP/IP Stack can be obtained from the lwIP Git repository. Instructions for accessing this repository may be found at: <https://savannah.nongnu.org/projects/lwip/>

Clockaudio Ltd.

Unit C, Wellington Gate, Silverthorne
Way, Waterlooville, Hampshire PO7 7XY,
UK

Tel: +44(0)23 9225-1193

Email: info@clockaudio.co.uk

Clockaudio North America Inc.

2891 Rue du Meunier, Unit 103,
Vaudreuil-Dorion, QC, Canada J7V 8P2

Toll Free: 1-888-424-9797

Tel: 450-424-9797

Email: info@clockaudio.com

Clockaudio PTE Ltd.

BizTech Centre, Unit # 01-02, 627A
Aljunied Road, Singapore, 389842

Tel: +65 67484738

Email: info@clockaudio.com.sg